









Technical Specifications

YD-500CC 2024

 Security Level (DIN 66399)	<i>P-2/O-2/T-2/E-2</i>	<i>P-3/O-2/T-3/E-2</i>	<i>P-4/O-3/T4/E-3</i>	<i>P-5/O-4/T5/E-4/F-2</i>
 Feed Width (mm)	500	500	500	500
 Cut Size (mm)	10.5x40-75	6x50	3.8x40	1.9x15
 Max Sheets	500-550	340-380	180-200	90-100
 Weight (kg)	1200	1200	1200	1200
 Power	7.5KW 3 x 400 V/50 Hz	7.5KW 3 x 400 V/50 Hz	7.5KW 3 x 400 V/50 Hz	9.5KW 3 x 400 V/50 Hz
 L×W×H (mm)	1318×1843×1638	1318×1843×1638	1318×1843×1638	1318×1843×1638
 Bin(L)	550L	550L	550L	550L





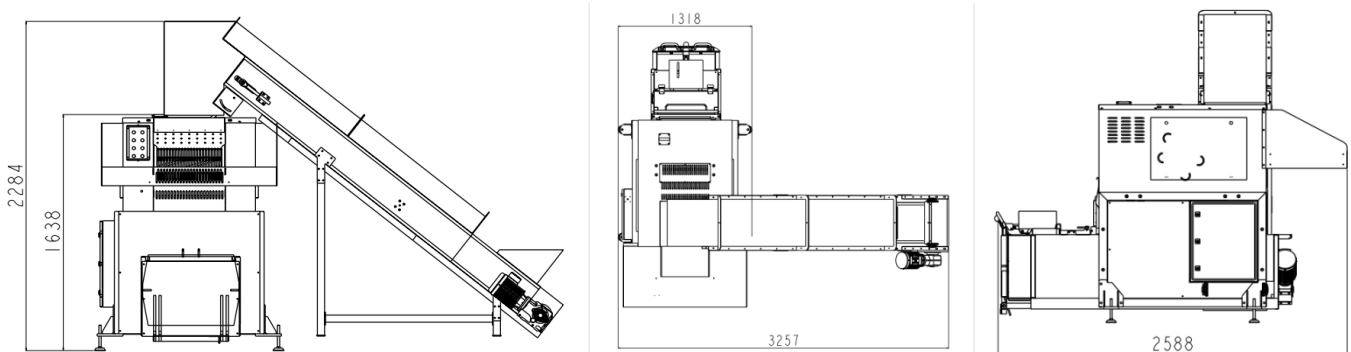

+ Optional Add-ons:

Floor-mounted conveyor and rear baling system
for efficient shredding and compact waste handling.



500CC shredder + 10T baler combo, ideal for secure rooms and archives.

Shreds up to 500 kg/h, compresses into 50–75 kg paper bales.

-  Output/h: 500–600 kg
-  Bale Weight: 50–75 kg
-  Baling Pressure: 85 kN
-  Power: 11.5 kW, 3 phase 400 V / 50 HZ
-  L×W×H (mm): 3257*2588*2284
-  System Overview: Three-View Diagram

YUEDU YD-500CC

500-Sheet Capacity

Industrial Secure Destruction Center Hub

Ultimate Throughput for Destruction Centers

- **500-Sheet Massive Feeding:** Capable of shredding 500 sheets in a single pass, designed for large-scale centralized destruction centers.
- **System Integration:** Features a 500mm wide opening (upgradable to 600mm) that seamlessly integrates with **conveyor belt feeding** and **waste balers** for an automated workflow.

Multi-Media Professional Destruction

- **Beyond Paper:** Effortlessly destroys complex media including bound books (with staples/clips), passports, magnetic tapes, and various digital storage devices.

Industrial Safety & Smart Maintenance

- **Automated Oiling System:** Equipped with a motorized oiling device to ensure the blades remain lubricated for long-term high-load performance.
- **Advanced Safety Interlocks:** Includes an electronic safety gate, a master power switch, and a high-visibility emergency stop press-switch.
- **Frameless Waste Bag Design:** Features an intelligent sensor that automatically stops the machine when the bag is full.

Integrated Solid Steel Cutting Blades

Feed opening width up to **500 mm**
(upgradable to **600 mm**)

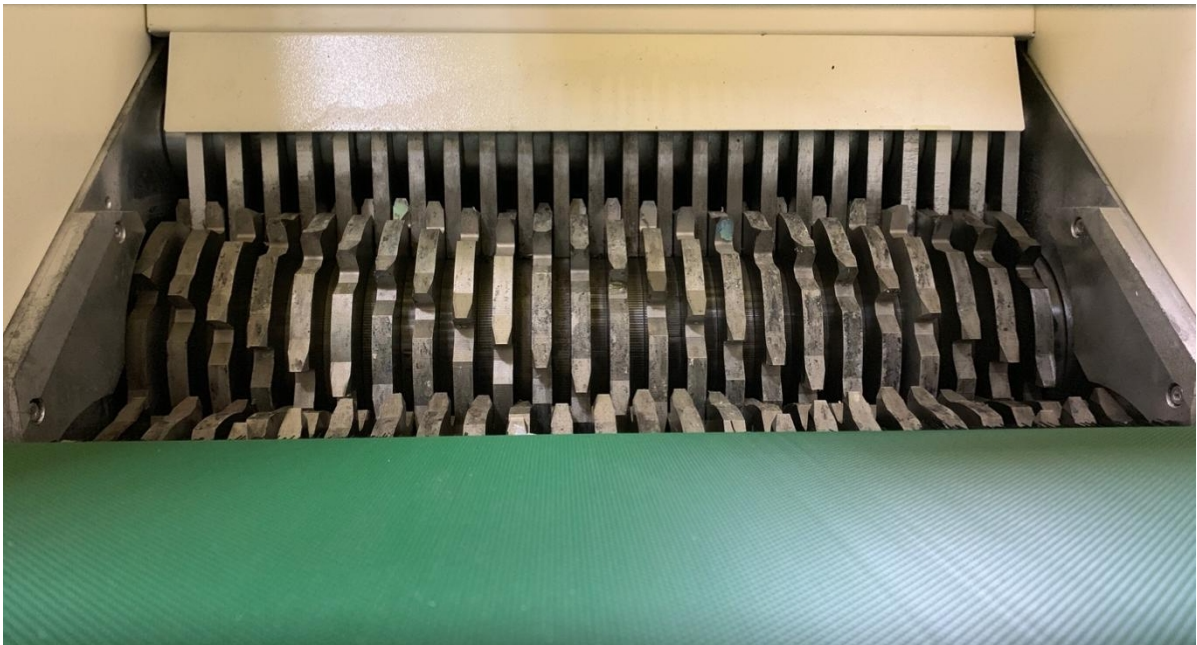

Client Sites

500CC shredder + 10T baler combo





Business License (Official Chinese & English Translation)



Business License (Translated Version)

Shanghai Yuedu Technology Co., Ltd.

◆ Company Information

Company Name:

Shanghai Yuedu Technology Co., Ltd.

Unified Social Credit Code:

91310114MA1GUXHQ8H

Company Type:

Limited Liability Company (Invested or Controlled by Natural Persons)

Registered Address:

Room 17239, Building 2, No. 4268 Zhen'nan Road, Jiading District, Shanghai, China

Legal Representative:

Deng Hao

Registered Capital:

RMB 3,700,000

◆ Registration Details

Date of Establishment:

September 5, 2018

Business Term:

From September 5, 2018 to September 4, 2048

◆ Registration Authority

Shanghai Jiading District Administration for Market Regulation

Date of Issue:

September 5, 2018



This document is a translated version of the original Chinese business license.

In case of any discrepancy, the original Chinese version shall prevail.

- ✓ Registered and verified company in China
- ✓ Officially issued by Chinese government authority
- ✓ Valid for international business cooperation

Website(Global): www.yuedushredders.com

Email: yuedushredders@gmail.com

Phone WhatsApp: +86 159 0178 2779

Contact Us

Johnny Deng, Managing Director

 Phone: +86 159 0178 2779 (WhatsApp / WeChat / Facebook / Telegram)

 Email: denghao8410@gmail.com

Shanghai YUEDU Technology Co., Ltd. (YUEDU Shredders)

 **Website(Global):** www.yuedushredders.com

 **Email:** yuedushredders@gmail.com / denghao8410@gmail.com

 **Sales Supervisor:** +86 159 0178 2779 (WhatsApp / WeChat / Facebook / Telegram)

 **Administrative Supervisor:** +86 137 6138 5116

 **Head Office Main Line:** +86 21 519 000 20

 **Company Headquarters:** Building 12, No. 555 Chengyin Road, Baoshan City Industrial Park, Shanghai, China

About YUEDE Shredders

Shanghai YUEDU Technology Co., Ltd. is a **Shanghai-certified high-tech enterprise** specializing in the development and manufacturing of **shredding and destruction equipment**. We serve a wide range of sectors including **government agencies, financial institutions, military departments, enterprises, and recycling industries**.

Our offerings include **office and industrial-grade paper shredders, hard drive destroyers, plastic crushing systems, and fully customized destruction center solutions**. From design to delivery, we help clients achieve efficient, secure, and compliant material destruction.

Our Mission

We are dedicated to the shredding and destruction industry, continuously solving diverse material shredding and disposal challenges for our clients around the world.

 **Website(Global):** www.yuedushredders.com

 **Email:** yuedushredders@gmail.com

 **Phone WhatsApp:** +86 159 0178 2779